

Sunbeam^{TM/MC}

User Manual **2-Slice & 4-Slice Toasters**
Notice d'emploi **Grille-pain 2 ou 4 tranches**

MODELS
MODÈLES

**3819, 3822, 3823,
3910, 3911, 3912**

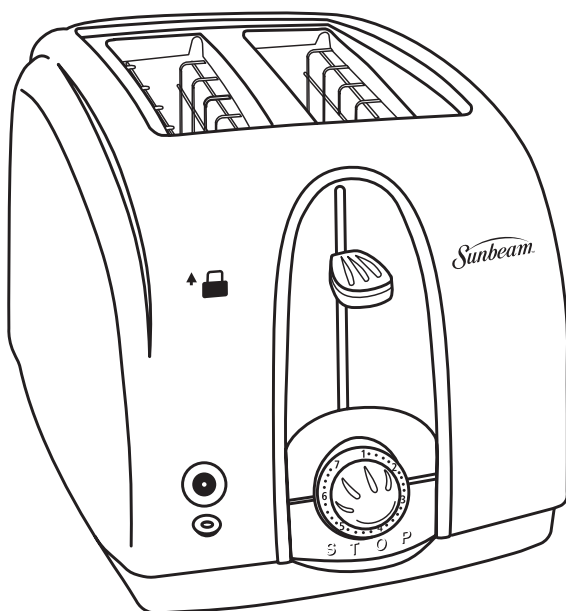

www.sunbeam.ca

P.N. 163463

*The product you purchase may differ slightly from the one shown in this manual due to the variety of models.
Le produit que vous achetez peut différer légèrement de celui qui est illustré par suite de la variété de modèles.*

IMPORTANT SAFEGUARDS

When using electrical appliances, basic safety precautions should always be followed including the following:

READ ALL INSTRUCTIONS BEFORE USE

- **Do not** touch hot surfaces. Metal parts can become hot. Use handles or knobs. All chrome surfaces become extremely hot.
- To protect against electrical shock, do not immerse cord, plug or toaster in water or other liquids.
- This appliance should not be used by young children or incapacitated persons. Supervise older children closely.
- **Do not** attempt to dislodge food when toaster is plugged in.
- **Do not** insert fingers or metallic utensils into slots when toaster is plugged in.
- **Do not** operate toaster near flammable materials such as curtains, draperies, walls, wall fabric, etc., to prevent fire.
- Unplug from outlet when not in use and before cleaning. Allow to cool before putting on or taking off parts.
- **Do not** insert utensils or foil-covered or oversized foods in toaster as they may involve a risk of fire or electric shock.
- **Do not** pull, twist or otherwise abuse cord.
- Clean out accumulated crumbs frequently to avoid risk of fire or toaster malfunction. Unplug when not in use and before cleaning.
- **Special Note: Do not** use foods that will drip coatings or fillings when heated. Such accumulations inside the toaster create unsanitary conditions and the possibility of fire or toaster malfunction.
- **Do not** operate any electrical appliance with a damaged cord or plug or after the appliance malfunctions or has been dropped or damaged in any manner. Contact your nearest Authorized Sunbeam Service Center for examination, repair, or adjustment. To disconnect, turn any control off then remove from outlet.

- Take care to **never** let a power cord hang over the edge of a table or countertop, where it can be accidentally pulled or touch any hot surface.
- **Do not** use outdoors or for commercial purposes.
- **Never** operate any appliance on top of a non-heat-resistant or flammable surface.
- **Never** leave appliance unattended when in use.
- **Do not** place appliance on or near a hot gas stove flame or electrical element, in a heated oven or microwave oven.
- Use this appliance only for its intended use as described in this manual.
Do not use attachments that are not recommended by manufacturer; they may cause injury.

SAVE THESE INSTRUCTIONS

SPECIAL INSTRUCTIONS

THIS UNIT IS FOR HOUSEHOLD USE ONLY

A short power supply cord is provided to reduce the risk of becoming entangled in or tripping over a long cord. Extension cords may be used if care is exercised in their use. If an extension cord is used, the marked electrical rating of the extension cord should be at least as great as the electrical rating of the appliance. The cord should be arranged so that it will not drape over the countertop or tabletop where it can be pulled on by children or tripped over unintentionally.

POLARIZED PLUG INFORMATION

To reduce the risk of electrical shock, this appliance has a polarized plug (one blade is wider than the other). As a safety feature, this plug will fit in a polarized outlet only one way. If the plug does not fit fully into the outlet, reverse the plug. If it still does not fit, contact a qualified electrician. Do not attempt to defeat this safety feature.

WELCOME

Congratulations! You are the owner of a SUNBEAM™ Toaster. Before you use this product for the first time, please take a few moments to read these instructions and keep it for reference. Pay particular attention to the Safety Instructions provided. Please review the product service and warranty statements.

LEARNING ABOUT YOUR TOASTER

This toaster is equipped with many safety and convenience features to give you optimum performance.

- A. Extra wide slots allow toasting of homemade bread, bagels, English muffins and pastries.
- B. Dual self-adjusting bread guides automatically adjust to bread thickness.
- C. Bread carriage lever is pressed to begin toasting.
- D. Toast lift – Press up on bread carriage lever to lift toast out of the bread slots.
- E. Light/dark selector knob lets you select the toast darkness.
- F. Stop button is pressed to stop the toasting process.
- G. Bagel Button
- H. CoolTouch™ Exterior.
- I. Pull-out, non-stick crumb tray. (Back of unit)

Note: 4-slice model shares same features as 2-slice model.

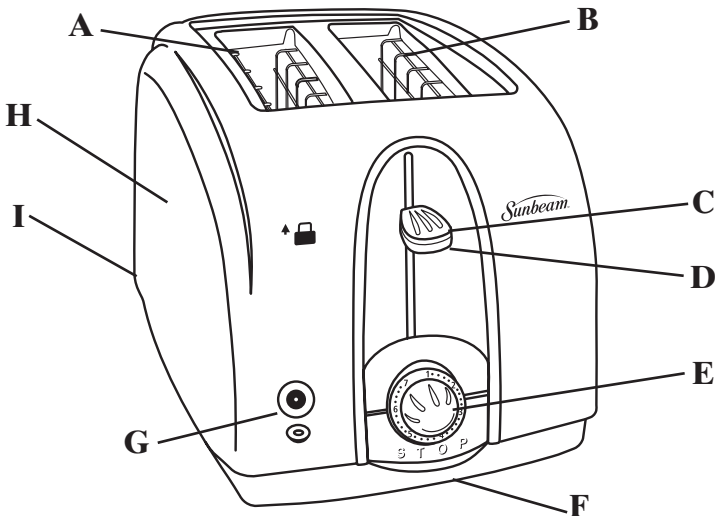

USING YOUR TOASTER

- Before use remove any stickers and wipe the body of your toaster with a damp cloth.
- Ensure that before plugging the toaster into the outlet, the bread carriage lever is in the resting position.
- Plug the cord into a 120/127 volt, 60 HZ AC outlet. Position toaster at least 3 inches away from wall or rear of counter.
- Let the first toasting process take place without inserting any bread to preheat the new elements and burn off any dust, which may have accumulated during storage. It is normal for this burnoff to create an odor. Your SUNBEAM™ toaster is now ready for use.
- Select the desired level of darkness by turning the “1-7” light/dark knob on the front panel of the toaster to the right for darker toast and to the left for lighter toast. Your selection should vary based on the moisture content, thickness of bread or bagel, whether fresh or frozen and your darkness preference.
- Next, place bread in slot and press bread carriage lever downward until it locks. Carriage lever will not stay down if toaster is not plugged in. The self-adjusting bread guides will automatically center the bread for even browning.

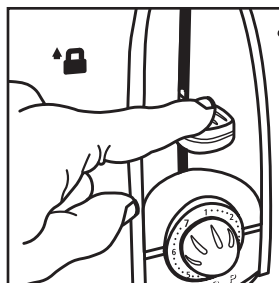
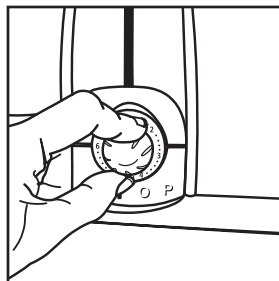

USING THE BAGEL FEATURE

- If you would like to toast bread, make sure that the bagel indicator is not lit. If it is unlit, then the toaster is set to toast bread.
- Press the bagel button if you are going to toast a bagel. The bagel indicator will light. This option will allow the toaster to adjust the time needed to toast bagels according to the shade level selected.
- After the desired level of darkness has been reached, the bread or bagel will pop up automatically and is ready for removal from the slots. The bread carriage will return to its original position and disconnect the elements, ready for the next toasting.
- To remove toast or bagel, press up on the bread carriage lever to lift toast out of the bread slots.
- To remove jammed toast or bagel, unplug toaster and remove bread or bagel once toaster has cooled down. **Never insert fingers or metallic utensils into slots.**

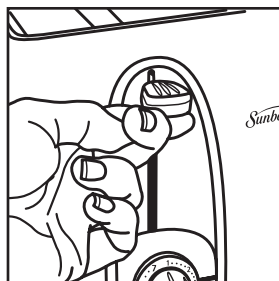

Do not wrap the cord around the main body of appliance during or after use.

USEFUL HINTS

- If you wish to cancel the toasting process, press the stop button. The toaster will stop immediately and the food will pop up automatically.
- Most types of breads and pastries can be toasted; such as bagels, tea cakes, thick sliced breads, English muffins, waffles, etc. Slices should not, however, be so thick as to cause burning or jamming in the bread slots.

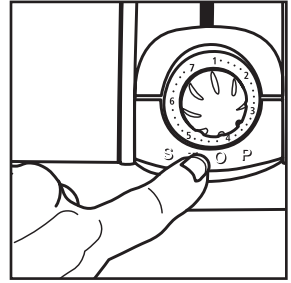

ADJUSTING THE POWER CORD LENGTH

Your toaster's cord storage area allows you to adjust the length of the power cord so that it is the exact length you desire.

- To adjust the length of the power cord: Wrap the power cord around the cord storage posts on the base of the toaster until the cord is the length you desire.

CARE AND CLEANING

- After use and before cleaning, unplug wall plug and wait for toaster to cool.
- Wipe the outside of toaster with a damp cloth and dry with another cloth or paper towel. Do not use abrasive cleaners.
- To avoid damage to toaster heating elements, do not use any pointed or sharp articles for cleaning the inside of the toaster.
- **Attention:** Empty the crumb tray frequently. Crumbs will accumulate in the crumb tray and could catch fire if not emptied periodically. When the toaster has cooled down completely, tap the sides of the toaster lightly to dislodge any crumbs caught in the toaster chamber and remove the crumb tray and empty it. Wipe the tray clean with a damp cloth or place it in the top rack of your dishwasher for cleaning. Tap sides again to ensure proper disposal. Return crumb tray back into the toaster before using again.

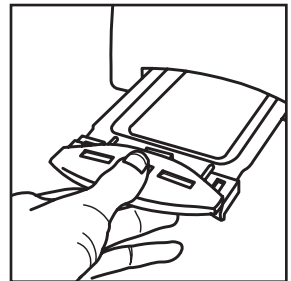

1-YEAR LIMITED WARRANTY

Sunbeam Products, Inc., doing business as Jarden Consumer Solutions, or if in Canada, Sunbeam Corporation (Canada) Limited doing business as Jarden Consumer Solutions (collectively “JCS”) warrants that for a period of one year from the date of purchase, this product will be free from defects in material and workmanship. JCS, at its option, will repair or replace this product or any component of the product found to be defective during the warranty period. Replacement will be made with a new or remanufactured product or component. If the product is no longer available, replacement may be made with a similar product of equal or greater value. This is your exclusive warranty.

This warranty is valid for the original retail purchaser from the date of initial retail purchase and is not transferable. Keep the original sales receipt. Proof of purchase is required to obtain warranty performance. JCS dealers, service centers, or retail stores selling JCS products do not have the right to alter, modify or any way change the terms and conditions of this warranty.

This warranty does not cover normal wear of parts or damage resulting from any of the following: negligent use or misuse of the product, use on improper voltage or current, use contrary to the operating instructions, disassembly, repair or alteration by anyone other than JCS or an authorized Sunbeam service center. Further, the warranty does not cover: Acts of God, such as fire, flood, hurricanes and tornadoes.

What are the limits on JCS’s Liability?

JCS shall not be liable for any incidental or consequential damages caused by the breach of any express, implied or statutory warranty or condition.

Except to the extent prohibited by applicable law, any implied warranty or condition of merchantability or fitness for a particular purpose is limited in duration to the duration of the above warranty.

JCS disclaims all other warranties, conditions or representations, express, implied, statutory or otherwise.

JCS shall not be liable for any damages of any kind resulting from the purchase, use or misuse of, or inability to use the product including incidental, special, consequential or similar damages or loss of profits, or for any breach of contract, fundamental or otherwise, or for any claim brought against purchaser by any other party.

Some provinces, states or jurisdictions do not allow the exclusion or limitation of incidental or consequential damages or limitations on how long an implied warranty lasts, so the above limitations or exclusion may not apply to you.

This warranty gives you specific legal rights, and you may also have other rights that vary from province to province, state to state or jurisdiction to jurisdiction.

How To Obtain Warranty Service

In the U.S.A.

If you have any question regarding this warranty or would like to obtain warranty service, please call 1 800-458-8407 and a convenient service center address will be provided to you.

In Canada

If you have any question regarding this warranty or would like to obtain warranty service, please call 1 800-667-8623 and a convenient service center address will be provided to you.

In the U.S.A., this warranty is offered by Sunbeam Products, Inc., doing business as Jarden Consumer Solutions located in Boca Raton, Florida 33431. In Canada, this warranty is offered by Sunbeam Corporation (Canada) Limited, doing business as Jarden Consumer Solutions located at 20B Hereford Street, Brampton, Ontario L6Y 0M1

PLEASE DO NOT RETURN THIS PRODUCT TO ANY OF THESE ADDRESSES OR TO THE PLACE OF PURCHASE.

Sunbeam™/MC

For product questions:
Sunbeam Consumer Service
USA: 1.800.458.8407
Canada: 1.800.667.8623
www.sunbeam.ca

©2012 Sunbeam Products, Inc. doing business as Jarden Consumer Solutions.
All rights reserved.

In Canada, imported and distributed by Sunbeam Corporation (Canada) Limited doing
business as Jarden Consumer Solutions, 20 B Hereford Street, Brampton, Ontario L6Y 0M1.

Pour toute question en ce qui concerne ce produit,
appelez le service à la clientèle de Sunbeam:

États-Unis : 1 800 458 8407
Canada : 1 800 667.8623
www.sunbeam.ca

©2012 Sunbeam Products, Inc., faisant affaire sous le nom de Jarden Consumer Solutions.
Tous droits réservés.

Au Canada, importé et distribué par Sunbeam Corporation (Canada) Limited faisant
affaire sous le nom de Jarden Consumer Solutions,
20B Hereford Street, Brampton (Ontario) L6Y 0M1.

www.sunbeam.ca