

TRUSTED FOR OVER
100 YEARS

*Sunbeam*TM

SSF2120-CN
SSF2120B-CN
SSF2120W-CN

20-inch (50cm) Power Stand Fan

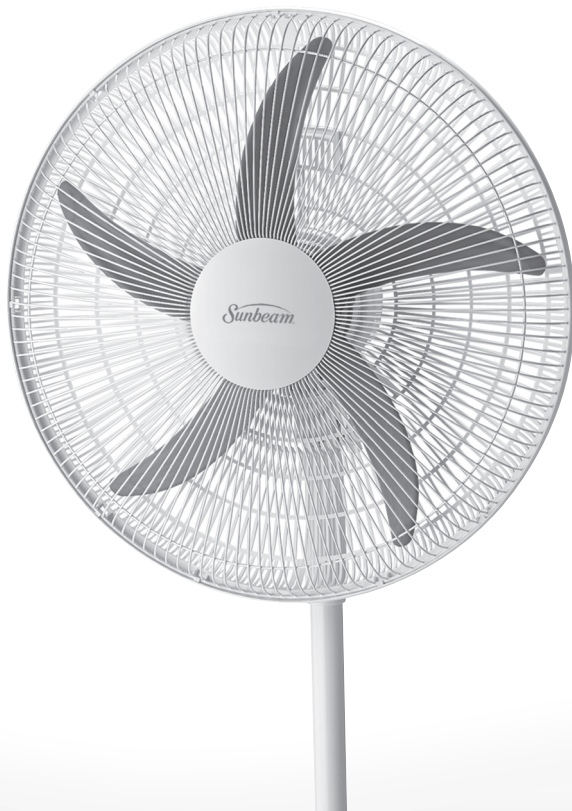

Instruction Leaflet

PLEASE READ AND SAVE THESE IMPORTANT INSTRUCTIONS

PLEASE READ AND SAVE THESE IMPORTANT SAFETY INSTRUCTIONS

When using electrical appliances, basic safety precautions should always be taken including the following:

1. Read all instructions before using this appliance.
2. Use fan only for purposes described in the instruction manual.
3. To protect against electrical shock do not immerse unit, plug or cord in water or spray with liquids and plug the appliance directly into a 120V AC electrical outlet.
4. Close supervision is necessary when any appliance is used by or near children.
5. Unplug from outlet when not in use, when moving fan from one location to another, before putting on or taking off parts and before cleaning.
6. Avoid contact with moving parts.
7. Do not operate in the presence of explosive and/or flammable fumes.
8. To avoid fire hazard, NEVER place the cord under rugs or any parts near an open flame, cooking or other heating appliance.
9. Do not operate any appliance with a damaged cord or plug after the appliance malfunctions, or has been dropped/damaged in any manner.
10. Do not run cord under carpeting. Do not cover cord with throw rugs, runner, or similar coverings. Do not route cord under furniture or appliances. Arrange cord away from traffic area and where it will not be tripped over.
11. The use of attachments not recommended or sold by the appliance manufacturer may cause hazards.
12. Do not let the cord hang over the edge of a table, counter or come in contact with hot surfaces or leave exposed to high traffic areas.
13. Do not use outdoors.
14. To disconnect, grip plug and pull from wall outlet. Never yank on cord.
15. Always use on a dry, level surface.
16. Do not operate fan until fully assembled with all parts properly in place.
17. This product is intended for household use ONLY and not for commercial or industrial applications.
18. **WARNING:** To reduce the risk of electrical shock and injury to persons, do not use in window.
19. **WARNING:** To reduce the risk of fire or electric shock, do not use this fan with any solid-state speed control device.

PLEASE READ AND SAVE THESE IMPORTANT SAFETY INSTRUCTIONS

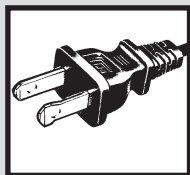

THIS APPLIANCE HAS A POLARIZED PLUG (one blade is wider than the other). To reduce the risk of electric shock, this plug is intended to fit in a polarized outlet only one way. If the plug does not fit fully in the outlet, reverse the plug. If it still does not fit, contact a qualified electrician to install the proper outlet.

DO NOT ATTEMPT TO MODIFY THIS PLUG OR DEFEAT THIS SAFETY FEATURE IN ANY WAY.

FEATURES - OPERATIONS

ASSEMBLY INSTRUCTIONS

Base Assembly (See Figure 1)

You will need the base and four extension legs. Push in the small tab located on the bottom of each extension leg and snap into base.

Figure 1

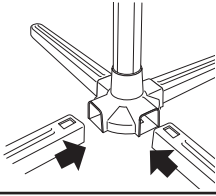

Pole Assembly (See Figure 2)

STEP 1: Remove the height adjustment collar from the base by turning counter clockwise.

STEP 2: Take the pole assembly, with the solid end down, and insert it into the base. The hollow end of the pole will be facing up.

STEP 3: Replace the height adjustment collar over the pole assembly, slide it down the pole, and secure it to the base by turning clockwise (Refer to Figure 2).

Figure 2

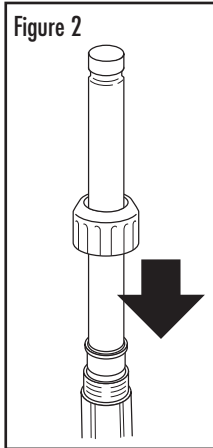

Fan Head Assembly (See Figure 4 - 6)

STEP 1: Position the rear grill over the motor shaft, making certain the 2 notches at the top and bottom of the rear grill fit over the 2 prongs on the motor housing.

Please make sure the rear grill fits securely against the motor housing (Refer to Figure 4).

STEP 2: Secure the rear grill in its place using the rear grill mounting-ring. Turn this ring clockwise and tighten firmly (Refer to Figure 5).

STEP 3: Slide the fan blade; with the hollowed interior of the blade facing towards the rear grill firmly onto the motor shaft. Make sure the shaft protrudes from the front of the blade (Refer to Figure 6).

STEP 4: Secure the fan blade onto the motor shaft by turning the fan blade cap in a counter-clockwise direction until it is firmly in place (Refer to Figure 6).

STEP 5: Prepare the front grill by simply snapping the circular front grill logo plate in place.

STEP 6: Center the front grill by aligning the Sunbeam™ logo so it is horizontal and parallel to the floor. Then secure the front and rear grills completely together by snapping into place. Lastly, tighten the securing screw at the bottom of the rear grill.

Figure 4

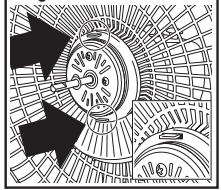

Figure 5

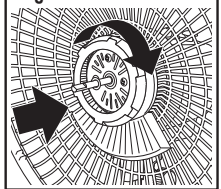
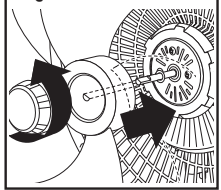

Figure 6



FEATURES - OPERATIONS

Final Assembly

First, place fan head assembly onto the upper pole, lining up the fan post screw with the hole in the extension pole. Then, simply insert the fan post screw into the hole and tighten until a secure fit is obtained. Lastly, insert the tilt adjustment knob into the neck joint and tighten in place.

NOTE: If your fan does not have a screw hole in the extension pole but instead has an indentation around the top of the pole; please do the following:

STEP 1: First, place the fan head assembly onto the upper pole and tighten the fan post screw until a secure fit is obtained.

STEP 2: Insert the tilt adjustment knob into the neck joint and tighten in place.

OPERATING INSTRUCTIONS

1. Set fan base on a dry, level surface.
2. Please make sure the Speed Control Knob is in the off position. The Speed Control Knob is located on the top of the Fan Motor Housing.
3. Plug cord into any standard 120 volt AC outlet.
4. The Speed is adjusted by turning the control knob to the desired setting, Off-High-Medium-Low (O-3-2-1).
5. The oscillation Control Knob is located on the top of the Fan Motor Housing. To Start Oscillation, push Control Knob down. To Stop Oscillation, pull Control Knob up.

ADJUSTMENT INSTRUCTIONS

Tilt Adjustment

Follow these instructions to tilt the Fan Head for upward angle air movement.

STEP 1: To change the tilting angle of the fan head; simply loosen the Tilt Adjustment Knob (see Figure 3).

STEP 2: Move the fan head to the desired angle, and firmly tighten the knob to lock in place.

Height Adjustment

Follow these instructions to adjust the height of the fan.

STEP 1: Turn the height adjustment collar counter-clockwise to loosen pole.

STEP 2: Adjust the extension pole to the desired height, and firmly tighten the height adjustment collar in a clockwise direction.

Figure 3

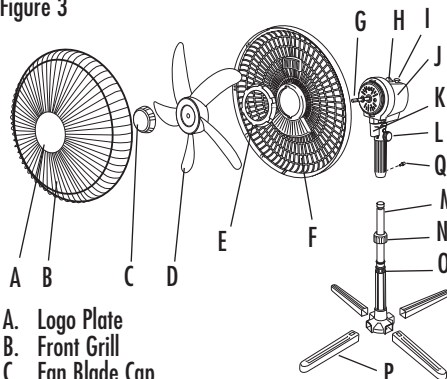

- | | |
|-----------------------------|-----------------------------|
| A. Logo Plate | K. Neck |
| B. Front Grill | L. Tilt-Adjustment Knob |
| C. Fan Blade Cap | M. Upper Pole |
| D. Fan Blade | N. Height Adjustment Collar |
| E. Rear-Grill Mounting Ring | O. Lower Pole |
| F. Rear Grill | P. Extension Legs |
| G. Motor Shaft | Q. Fan Post Screw |
| H. Speed Control Knob | |
| I. Oscillation Knob | |
| J. Motor Housing | |

WARRANTY INFORMATION

3 YEAR LIMITED WARRANTY

Sunbeam Products, Inc. doing business as Jarden Consumer Solutions or if in Canada, Sunbeam Corporation (Canada) Limited doing business as Jarden Consumer Solutions (collectively "JCS") warrants that for a period of three years from the date of purchase, this product will be free from defects in material and workmanship. JCS, at its option, will repair or replace this product or any component of the product found to be defective during the warranty period. Replacement will be made with a new or remanufactured product or component. If the product is no longer available, replacement may be made with a similar product of equal or greater value. This is your exclusive warranty. Do NOT attempt to repair or adjust any electrical or mechanical functions on this product. Doing so will void this warranty.

This warranty is valid for the original retail purchaser from the date of initial retail purchase and is not transferable. Keep the original sales receipt. Proof of purchase is required to obtain warranty performance. JCS dealers, service centers, or retail stores selling JCS products do not have the right to alter, modify or any way change the terms and conditions of this warranty.

This warranty does not cover normal wear of parts or damage resulting from any of the following: negligent use or misuse of the product, use on improper voltage or current, use contrary to the operating instructions, disassembly, repair or alteration by anyone other than JCS or an authorized JCS service center. Further, the warranty does not cover: Acts of God, such as fire, flood, hurricanes and tornadoes.

What are the limits on JCS's Liability?

JCS shall not be liable for any incidental or consequential damages caused by the breach of any express, implied or statutory warranty or condition.

Except to the extent prohibited by applicable law, any implied warranty or condition of merchantability or fitness for a particular purpose is limited in duration to the duration of the above warranty.

JCS disclaims all other warranties, conditions or representations, express, implied, statutory or otherwise.

JCS shall not be liable for any damages of any kind resulting from the purchase, use or misuse of, or inability to use the product including incidental, special, consequential or similar damages or loss of profits, or for any breach of contract, fundamental or otherwise, or for any claim brought against purchaser by any other party.

Some provinces, states or jurisdictions do not allow the exclusion or limitation of incidental or consequential damages or limitations on how long an implied warranty lasts, so the above limitations or exclusion may not apply to you.

This warranty gives you specific legal rights, and you may also have other rights that vary from province to province, state to state or jurisdiction to jurisdiction.

How to Obtain Warranty Service

In the U.S.A.

If you have any questions regarding this warranty or would like to obtain warranty service, please call 1-888-264-9669 and a convenient service center address will be provided to you.

In Canada

If you have any questions regarding this warranty or would like to obtain warranty service, please call 1-888-264-9669 and a convenient service center address will be provided to you.

In the U.S.A., this warranty is offered by Sunbeam Products, Inc. doing business as Jarden Consumer Solutions located in Boca Raton, Florida 33431. In Canada, this warranty is offered by Sunbeam Corporation (Canada) Limited doing business as Jarden Consumer Solutions, located at 20 B Hereford Street, Brampton, Ontario L6Y 0M1. If you have any other problem or claim in connection with this product, please write our Consumer Service Department. **PLEASE DO NOT RETURN THIS PRODUCT TO ANY OF THESE ADDRESSES OR TO THE PLACE OF PURCHASE.**

CLEANING / MAINTENANCE

CLEANING / MAINTENANCE INSTRUCTIONS

Follow these instructions to correctly and safely care for your stand fan. Please remember:

- Always unplug the fan before cleaning or disassembling.
- Do not allow water to drip on or into the fan motor housing.
- Be sure to use a soft cloth moistened with mild soap solution.
- Do not use any of the following as a cleaner: gasoline, thinner, benzene.

Fan Blade Cleaning

- STEP 1: To access the fan blade, remove the front grill and the fan blade cap.
- STEP 2: Clean the fan blade, front and rear grills with a soft, moist cloth.
- STEP 3: Replace blade, tighten blade cap, and securely fasten the front grill.

Fan Head, Base, and Pole Cleaning

Using a soft, moist cloth, with or without a mild soap solution, carefully clean the fan base, pole, and head. Please use caution around the motor housing area. Do not allow the motor or other electrical components to be exposed to water.

FAN STORAGE

Your fan can be stored in the off-season either partially disassembled or assembled. It is important to keep it in a safe, dry location.

- If stored disassembled, we recommend using the original (or appropriately sized) box.
- If stored assembled or partially assembled, remember to protect the fan head from dust.

If you have any questions regarding your product or would like to learn more about other Sunbeam™ products, please contact our Consumer Service Department at 1-888-264-9669 or visit our website at www.sunbeam.ca.